

REV	DESCRIPTION	DATE	BY
A	NEW DRAWING	03/01/06	H.N.

F7694

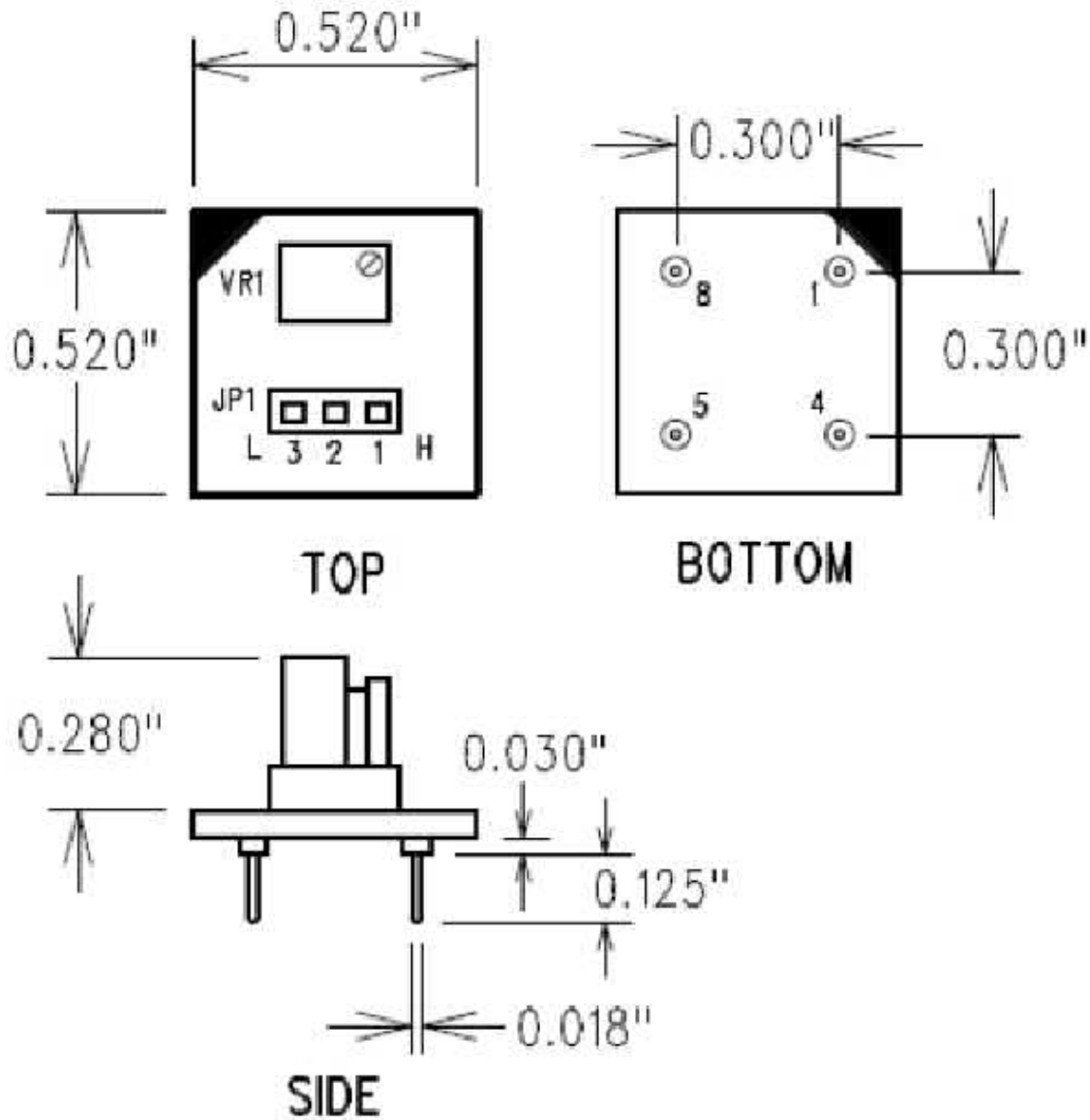

PACKAGE DRAWING

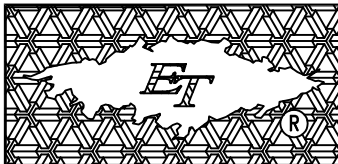

Emulation Technology, Inc.

— VLSI and SMT ADAPTERS and ACCESSORIES —

2344 Walsh Avenue, Bldg.F Santa Clara, Ca 95051
 TEL:(408)982-0660 FAX:(408)982-0664

SHEET: 1 OF 1	DATE: 03/01/06	REVISION: A	ASSEMBLY DRAWING
CHECKED: Perry Munroe	DRAWN: Huy Nguyen	ITEM: VROSDIP4.320165	
Scale N/A	DO NOT SCALE DRAWING	DESCRIPTION: VROS-DIP4.3-20165M	